

N°	Cod.	Descrizione	Description	Note	Q.ty	Model
1	0477 0155	Carenatura	Cover	Grigio / Grey	1	
	0477 0169	Carenatura	Cover	Azzurro / Cyan	1	
	0477 0176	Carenatura	Cover	Rosso / Red	1	
	0477 0189	Carenatura	Cover	Nero / Black	1	
	0477 0175	Carenatura	Cover	Giallo / Yellow	1	
2	1202 0059	Viti Carenatura	Cover Screw		5	
3	2803 0325	Raccordo Aspirazione	Suction Coupling		1	
	7304 0238	Motopompa	Motorpump		1	1700
4	7304 0237	Motopompa	Motorpump		1	1600
	2811 0023	Rondella	Washer	Ø6,4x12,5x1,7	1	1700
5	2811 0002	Rondella	Washer	Ø10,5x20x2	1	1600
	7002 0265	Kit Avvolgitubo Completo	Complete Hose Reel Kit	10 m R1	1	Extra
7	0604 0010	Dado	Nut	M6	1	1700
	0604 0105	Dado	Nut	M10	1	1600
8	2811 0023	Rondella	Washer	Ø6,4x12,5x1,7	2	1700
9	3206 0268	Telaio Superiore	Upper Frame		1	
10	0017 0012	Assale Ruota	Wheel Axle	Ø12 L=310	1	
11	2810 0103	Ruota	Wheel	Ø175	2	
12	0009 0273	Anello	Ring		2	
	0402 0417	Copriruota - Ø175	Wheel Cover - Ø175	Grigio / Grey	2	
13	0402 0420	Copriruota - Ø175	Wheel Cover - Ø175	Grigio Scuro / Dark Grey	2	
	0402 0418	Copriruota - Ø175	Wheel Cover - Ø175	Azzurro / Cyan	2	
14	0402 0419	Copriruota - Ø175	Wheel Cover - Ø175	Nero / Black	2	
	2811 0002	Rondella	Washer	Ø10,5x20x2	2	

N°	Cod.	Descrizione	Description	Note	Q.ty	Model
15	0604 0079	Dado	Nut	M10	2	
16	3625 0057	Vite	Screw	Ø5x25	3	
17	3625 0058	Vite	Screw	Ø5x30	4	
18	3625 0058	Vite	Screw	Ø5x30	6	
19	3206 0267	Telaio Inferiore	Lower Frame		1	
20	3208 0586	Tubo Detergente	Detergent Hose	Ø7x10 L=390	1	1700
21	2434 0046	Guarnizione Tubo Det.	Detergent Hose Seal		1	1700
22	3029 0018	Tanica Detergente	Detergent Tank	1,8 lt	1	1700
23	3200 0058	Tappo Serb. Detergente	Detergent Tank Cap	Rosso / Red	1	1700
24	3002 0573	Supporto Accessori	Accessories Support		1	Extra
25	0199 0239	Kit Ruota	Wheel Kit	Grigio / Grey	2	
	0199 0237	Kit Ruota	Wheel Kit	Grigio Scuro / Dark Grey	2	
	0199 0236	Kit Ruota	Wheel Kit	Azzurro / Cyan	2	
	0199 0164	Kit Ruota	Wheel Kit	Nero / Black	2	
26	0531 0158	Kit Tanica Detergente	Detergent Tank Kit		1	1700
27	0402 0265	Tappo in Plastica	Plastic Cap		2	Classic

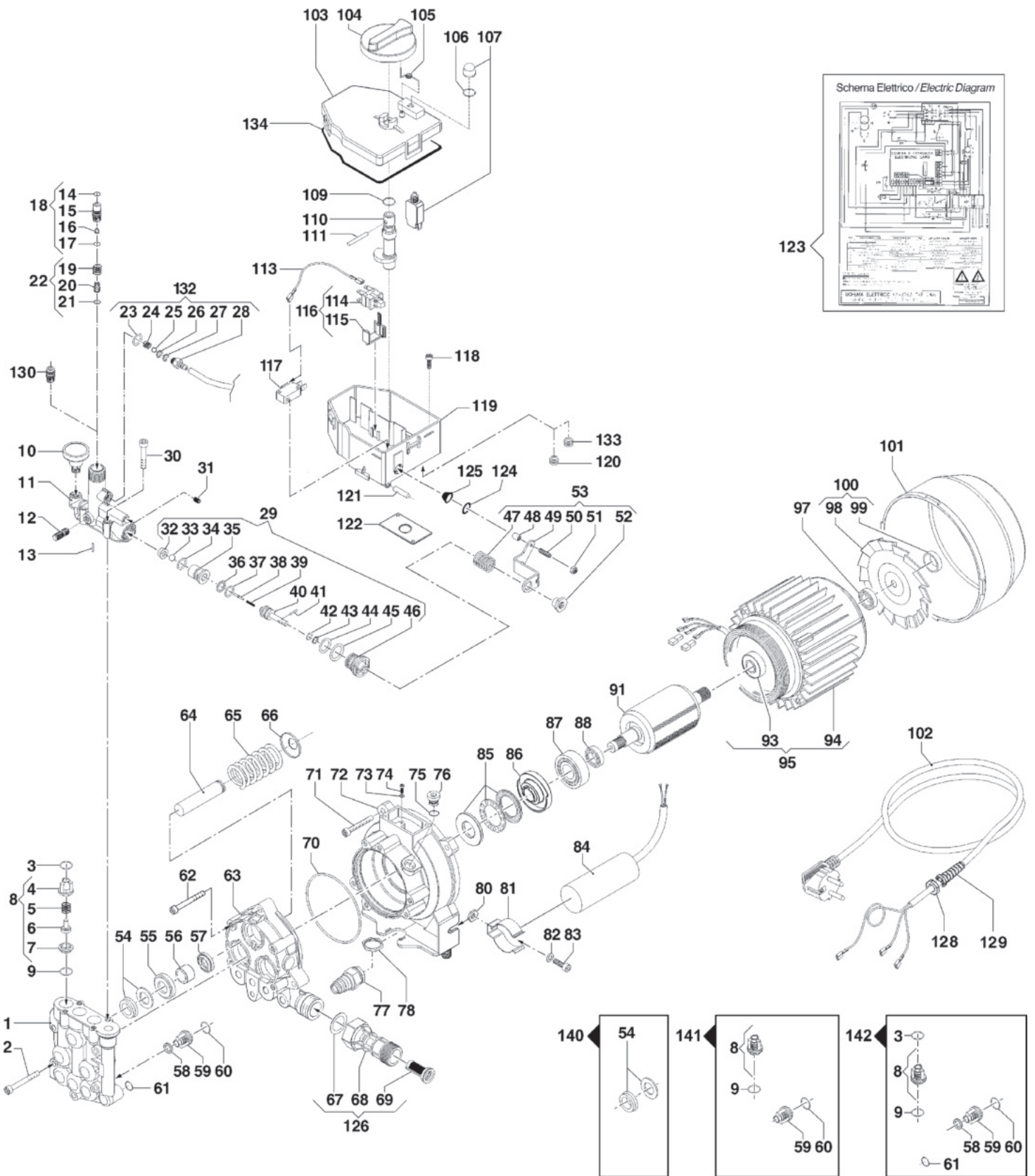



KS Classic - KS Extra

Motorpump - Pump Side

N°	Cod.	Descrizione	Description	Note	Q.ty	Model
1	3218 0114	Testata Pompa Ottone	Brass Pump Manifold		1	1700
	3218 0111	Testata Pompa Allum.	Allum. Pump Manifold		1	1600
2	3609 0150	Vite	Screw	M6x35	5	1700
	3609 0100	Vite	Screw	M6x35	5	1600
3	1210 0392	Guarnizione OR	O-Ring	Ø2x16	4	
4	1205 0031	Gabbia Valv. Asp./Mand.	Suct./Del. Valve Cage		3	
5	1802 0175	Molla	Spring		3	
6	3604 0026	Valvola Aspir./Mand.	Suct./Del. Valve		3	
7	3009 0121	Sede Valv. Aspir./Mand.	Suct./Del. Valve Seat		3	1700
	3009 0118	Sede Valv. Aspir./Mand.	Suct./Del. Valve Seat		3	1600
8	1220 0039	Gruppo Valv. Asp./Mand.	Suct./Del. Valve Ass.y kit		3	1700
	1220 0038	Gruppo Valv. Asp./Mand.	Suct./Del. Valve Ass.y kit		3	1600
9	1210 0415	Guarnizione OR	O-Ring	Ø1,78x12,42	3	1700
	1210 0049	Guarnizione OR	O-Ring	Ø1,78x12,42	3	1600
10	1816 0125	Manometro	Gauge	0-160 G1/8"	1	
11	0424 0391	Corpo Valvola	Unloader Body		1	1700
	0424 0384	Corpo Valvola	Unloader Body		1	1600
12	3622 0044	Vite	Adjustable Nut	M6x30	1	1700
13	3021 0035	Spina Elastica	Elastic Pin		1	1700
14	1210 0043	Guarnizione OR	O-Ring	Ø1,78x11,11	1	1700
15	2000 0108	Eiettore Detergente	Detergent Injector		1	1700
16	3400 0287	Ugello Detergente	Detergent Nozzle		1	1700
17	1210 0170	Guarnizione OR	O-Ring	Ø1,78x10,82	1	1700
18	3410 0326	Kit Eiettore	Injector Kit		1	1700
19	1802 0284	Molla	Spring		1	
20	3600 0087	Valvola Non Ritorno	Check Valve		1	
21	1210 0220	Guarnizione OR	O-Ring	Ø2x4	1	
22	5027 0025	Kit Valvola Non Ritorno	Check Valve Kit		1	
23	1210 0039	Guarnizione OR	O-Ring	Ø1,78x7,67	1	1700
24	1802 0254	Molla Conica	Conic Spring		1	1700
25	3003 0024	Sfera Detergente	Detergent Ball	7/32"	1	1700
26	1210 0014	Guarnizione OR	O-Ring	Ø1,78x4,48	1	1700
27	1209 0083	Guarnizione	Gasket		1	1700
28	2803 0383	Raccordo Detergente	Detergent Coupling		1	1700
29	1215 0337	Kit Valvola Regolaz.	Unloader Valve Kit		1	1700
	1215 0386	Kit Valvola Regolaz.	Unloader Valve Kit		1	1600
30	3609 0148	Vite	Screw	M5x35	4	
31	3622 0045	Vite	Stop Adjustable Nut	M6	1	
32	3009 0153	Sede Easy-Start	Easy-Start Seat		1	1700
	3009 0141	Sede Easy-Start	Easy-Start Seat		1	1600
33	3003 0028	Sfera Easy-Start	Easy-Start Ball	9/32"	1	
34	1210 0152	Guarnizione OR	O-Ring	Ø1,78x9,25	1	
35	3009 0148	Sede Valvola Regol.	Unloader Valve Seat		1	
36	0009 0112	Anello	Ring		1	
37	1210 0041	Guarnizione OR	O-Ring	Ø1,78x8,73	1	
38	2408 0162	Perno Easy-Start	Easy-Start Rod		1	
39	1802 0247	Molla Easy-Start	Easy-Start Spring		1	1700
	1802 0233	Molla Easy-Start	Easy-Start Spring		1	1600
40	0015 0184	Asta Valvola Regolaz.	Unloader Valve Rod		1	
41	3021 0035	Spina Elastica	Elastic Pin	Ø2,2x8	1	
42	1210 0055	Guarnizione OR	O-Ring	Ø1,78x6,07	1	
43	0009 0110	Anello	Ring		1	
44	1210 0049	Guarnizione OR	O-Ring	Ø1,78x12,42	1	
45	1210 0390	Guarnizione OR	O-Ring	Ø2x17	1	
46	3605 0115	Vite Speciale	Special Screw		1	
47	1802 0249	Molla Valvola Regolaz.	Unloader Valve Spring		1	
48	0432 0044	Cappuccio Total-Stop	Total-Stop Cap		1	
49	1600 0083	Leva Total-Stop	Total-Stop Lever		1	
50	3622 0047	Vite Total-Stop	Total-Stop Adjust. Nut	M4x20	1	
51	0604 0087	Dado	Nut	M4	1	
52	3202 0241	Vite Spec. Total-Stop	Total-Stop Special Screw		1	
53	1600 0089	Kit Leva Total-Stop	Total-Stop Lever Kit		1	
54	1241 0041	Guarnizione Tenuta	Packing	Ø14xØ22x5	3	
55	0009 0201	Anello Portaguarniz.	Packing Retainer		3	
56	0601 0310	Distanziale Paraolio	Oil Seal Spacer		3	
57	0019 0058	Anello Tenuta Olio	Oil Seal	Ø14x22x5	3	
58	0601 0261	Distanziale	Shim	Ø11x16x0,7	3	1700
59	1220 0039	Gruppo Valv. Asp./Mand.	Suct./Del. Valve Ass.y kit		3	1700
	1220 0038	Gruppo Valv. Asp./Mand.	Suct./Del. Valve Ass.y kit		3	1600
60	1210 0432	Guarnizione OR	O-Ring	Ø2x12 NBR 90	3	1700
	1210 0393	Guarnizione OR	O-Ring	Ø2x12 NBR 90	3	1600
61	1210 0433	Guarnizione OR	O-Ring	Ø2x8	1	
62	3609 0100	Vite	Screw	M6x35	3	
63	2432 0014	Carter Pompa	Pump Crankcase		1	
64	2409 0108	Pistone	Piston	Ø14	3	
65	1802 0174	Molla Pistone	Piston Spring		3	
66	0009 0195	Anello Pistone	Piston Ring		3	
67	1209 0111	Guarnizione	Gasket		1	

N°	Cod.	Descrizione	Description	Note	Q.ty	Model
68	2803 0487	Raccordo Ingresso	Inlet Coupling	G3/4 M	1	
69	1002 0132	Filtro Aspirazione	Suction Filter		1	
70	1210 0770	Guarnizione OR	O-Ring	Ø2,62x79,05	1	
71	3609 0114	Vite	Screw	M6x30	4	
72	1009 0212	Kit Flangia Motore	Motor Flange Kit		1	
73	2807 0013	Rondella Speciale	Special Washer	Ø4,3x8x1,5	1	
74	3625 0072	Vite	Screw	M4x8	1	
75	1210 0557	Guarnizione OR	O-Ring	Ø3x9	1	
76	3202 0220	Tappo Olio	Oil Plug		1	
77	2434 0027	Pressacavo Cavo Elettr.	Cable Holder		1	
78	1227 0028	Ghiera	Ring Nut		1	
80	0604 0095	Dado	Nut	M7	1	
81	1802 0224	Fissaggio Condensatore	Condenser Holder		1	
82	2811 0030	Rondella	Washer	Ø6,4x12x1,6	1	
83	3609 0193	Vite	Screw	M6x10	1	
84	0434 0021	Condensatore	Condenser	50 mF	1	1700
	0434 0045	Condensatore	Condenser	30 mF	1	1600
85	0436 0032	Cuscinetto	Bearing	Ø40x60x14	1	
86	0001 0472	Albero Eccentrico	Eccentric Shaft		1	1700
	0001 0465	Albero Eccentrico	Eccentric Shaft		1	1600
87	0438 0069	Cuscinetto a Sfere	Ball Bearing	Ø20x52x15	1	
88	0019 0113	Anello Tenuta Olio	Oil Seal	Ø20x32x7	1	
91	0001 0940	Albero Rotore	Rotor Shaft		1	1700
	0001 0598	Albero Rotore	Rotor Shaft		1	1600
93	0438 0099	Cuscinetto a Sfere	Ball Bearing	Ø20x47x14	1	1700
	0438 0083	Cuscinetto a Sfere	Ball Bearing	Ø20x47x14	1	1600
94	3041 0391	Statore	Stator		1	1700
	3041 0202	Statore	Stator		1	1600
95	3041 0373	Kit Statore	Stator Kit		1	1700
	3041 0203	Kit Statore	Stator Kit		1	1600
97	0019 0115	Anello Tenuta	Seal	Ø18x26x7	1	
98	3632 0070	Ventola Motore	Motor Fan		1	
99	0009 0280	Anello Ventola Motore	Motor Fan Ring		1	
100	3632 0072	Kit Ventola Motore	Motor Fan Kit		1	
101	0466 0027	Copriventola Motore	Motor Fan Cover		1	
102	0456 0180	Cavo Elettrico	Electrical Cable		1	
	0456 0237	Cavo Elettrico	Electrical Cable		1	U.K. Version
	0456 0192	Cavo Elettrico	Electrical Cable		1	Australian - N.Z. Version
103	3001 0156	Coperchio Scatola Elettr.	Electrical Box Cover		1	
104	1817 0065	Manopola Interruttore	Switch Knob		1	
105	1802 0222	Molla	Spring		1	
106	1209 0121	Guarnizione OR	O-Ring	Ø9,5x15,5x1	1	
107	1410 0096	Interruttore Termico	Thermo Switch		1	1700
	1410 0094	Interruttore Termico	Thermo Switch		1	1600
109	1210 0465	Guarnizione OR	O-Ring	Ø1,78x8,73	1	
110	2408 0155	Leva Interruttore	Switch Lever		1	
111	3018 0014	Spina Elastica	Elastic Pin	2,5x22	1	
113	0456 0289	Cavo Elettrico	Electrical Cable		2	
114	1410 0104	Interruttore	Switch		1	
115	3002 0569	Supporto Interruttore	Switch Support		1	
116	1410 0098	Kit Interruttore	Switch Kit		1	
117	1825 0018	Interruttore Total-Stop	Total-Stop Switch		1	
118	3625 0046	Vite	Screw	5x12	2	
119	3001 0155	Scatola Elettrica	Electrical Box		1	
120	2434 0048	Pressacavo	Holder		1	
121	3018 0012	Spina Elastica	Elastic Pin	5x26	1	
122	1201 0153	Guarnizione	Gasket		1	
123	1610 0826	Schema Elettrico	Electric Diagram		1	
124	0009 0229	Anello	Ring		1	
125	2416 0112	Protezione	Protection		1	
126	2803 0513	Kit Raccordo	Coupling Kit		1	
128	1227 0028	Ghiera	Nut		1	
129	2434 0027	Pressacavo	Holder		1	
130	3202 0280	Tappo	Plug		1	1600
132	2803 0432	Kit Raccordo Deterg.	Detergent Coupling Kit		1	1700
133	2434 0048	Pressacavo	Holder		1	
134	1201 0152	Guarnizione	Gasket		1	

Kit Ricambi
Spare Parts Kit

140	5019 0033	Kit Guarnizioni Acqua	Water Seal Kit		1	
141	5025 0010	Kit Valvola Aspir./Mand.	Suction/Delivery Kit		1	1600
142	5025 0019	Kit Valvola Aspir./Mand.	Suction/Delivery Kit		1	1700

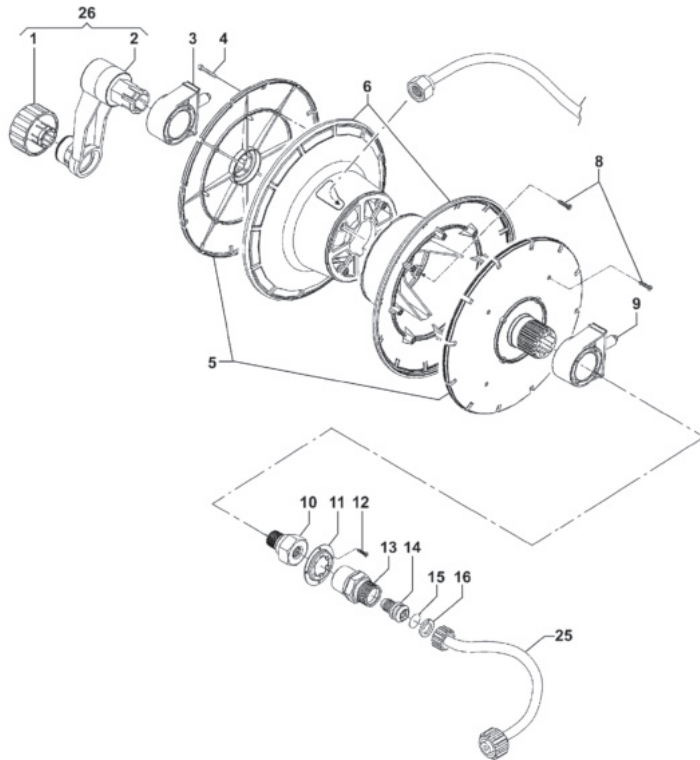

N°	Cod.	Descrizione	Description	Note	Q.ty	Model
1	2431 0007	Pomello	Knob		1	
2	1804 0005	Manovella	Handle		1	
3	3002 0568	Supporto Avvolgitubo	Hose Reel Support		1	
4	3625 0061	Vite	Screw	Ø4x17	4	
5	0602 0055	Disco Avvolgitubo	Hose Reel Disc		2	
6	0602 0054	Corpo Avvolgitubo	Hose Reel Body		2	
8	3625 0061	Vite	Screw	Ø4x17	8	
9	3002 0568	Supporto Avvolgitubo	Hose Reel Support		1	
10	2000 0110	Nipplo	Nipple		1	
11	1802 0225	Molla	Spring		1	
12	3625 0059	Vite	Screw	Ø3x12	4	
13	2000 0109	Raccordo Speciale	Special Coupling	M22x1,5	1	
14	3605 0106	Vite Speciale	Special Screw	M10x11	1	
15	1210 0170	Guarnizione OR	O-Ring	1,78x10,82	1	
16	0009 0279	Anello	Ring		1	
25	3208 0978	Tubo A.P. Collegamento	Connection H.P. Hose	R1 1/4" - L=750	1	
26	0199 0165	Kit Manovella	Handle Kit		1	

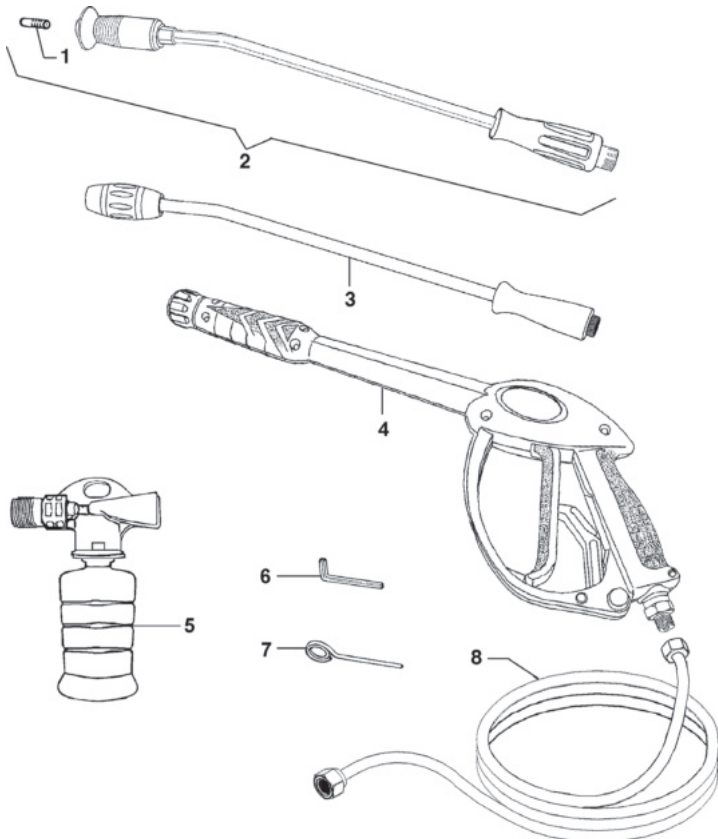

N°	Cod.	Descrizione	Description	Note	Q.ty	Model
1	3400 0510	Ugello Acqua	Water Nozzle	Ø1,25 (Blister COMET)	1	1700
	3400 0508	Ugello Acqua	Water Nozzle	Ø1,15 (Blister COMET)	1	1600
2	3301 1064	Lancia Angolata	Bent Lance	Ø1,25 (Blister COMET)	1	1700
	3301 0933	Lancia Angolata	Bent Lance	Ø1,15 (Blister COMET)	1	1600
	3301 0706	Lancia Angolata	Bent Lance	Ugello-Nozzle: Ø1,1	1	1700 U.K. Version
3	3301 1052	Lancia Ugello Rotante	Turbo Lance	(Blister COMET)	1	1700 Extra
	3301 1151	Lancia Ugello Rotante	Turbo Lance	(Blister COMET)	1	1600 Extra
	3301 0707	Lancia Ugello Rotante	Turbo Lance	Ugello-Nozzle: Ø1,1	1	1700 Extra U.K. Version
4	2410 0118	Pistola	Spray Gun	(Blister COMET)	1	
5	3301 0795	Lancia Aspir. Deterg.	Foam Lance Kit	(Blister COMET)	1	1600
6	0454 0037	Brugola Smont. Ugello	Key for Nozzle		1	
7	0455 0013	Spillo Pulizia Ugello	Nozzle Cleaning Pin		1	
8	3301 0794	Tubo A.P.	H.P. Hose	R1 1/4"-10m (Blister COMET)	1	Extra
	3301 0767	Tubo A.P.	H.P. Hose	1/4" - 8m (Blister COMET)	1	Classic
	3301 0785	Tubo A.P.	H.P. Hose	R1 1/4" - 8m (Blister COMET)	1	1700 Classic U.K. Version