



innova55



Innova 55 B has the same dimensions as a walk behind model: you can clean faster surfaces up to 3,000/32300 sq. m./ft2. Comac designed a scrubbing machine that is extremely convenient: indeed, with the same investment intended for a walk behind model is possible to have Innova 55 B, that is more user-friendly and faster in cleaning operations.

Innova 55 B is a ride on scrubbing machine with automatic traction, available in battery version with single disc brush of 56 cm working width.

THE ADVANTAGES OF INNOVA 55

Compared to a walk behind scrubbing machine Innova 55 B offers the following benefits:

- It lowers management and usage costs throughout its life-cycle since:
 - It requires little maintenance
 - It is built with top quality materials
 - It uses waste-reducing technologies
 - It scrubs more square metres in the same time
 - It is comfortable, safe and user-friendly
- It is silent: can clean in sensitive environments such as nursing homes, hospitals etc. without disturbing the environment thanks to the "Eco Mode" device, that reduces the sound level
- It is fast, twice the speed of a walk behind scrubbing machine
- Reduces CO2 emissions by up to 36%*.



MODELS

INNOVA 55 B
Scrubbing version with disc brush

Is safe for the operator and for the environment where it performs

SECURITY



EMERGENCY STOP
Immediate machine stop, just by pressing a single button



ANTI-OVERTURN BUMPER

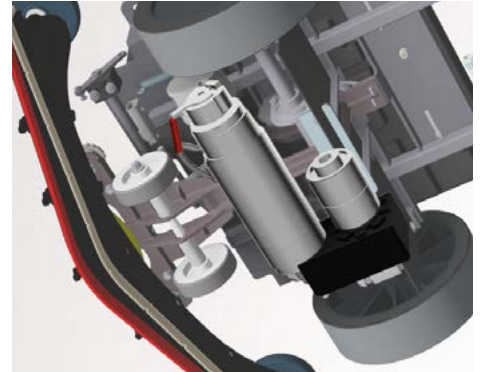

AUTOMATIC REDUCTION OF SPEED ON BENDS

ECO DEVICE

Only one button to reduce energy consumption and noise level **54 db(A)**.

It is an ideal working setting for maintenance cleaning and to use the machine in sensitive or frequented environments.



CFC - COMAC FLEET CARE

Innova 55 B can be arranged with the equipment needed for fleet management through Comac Fleet Care (CFC). Such system allows the remote control of machines status: if, when and where each machine is operating or if maintenance is needed, to let you promptly intervene avoiding machine downtimes and unexpected costs for extraordinary maintenance.



REFERENCE SECTORS



Cleaning companies



Health



Public



Horeca



Sports



Handicraft



Automotive



Retail



Large-Scale
Retail Trade



Transport

The simple design and the new steering wheel make it ergonomic and handy in any situation



The operator remains comfortably seated and can easily move in limited spaces, quickly passing from one area to another - even in a lift - in total safety



QUALITY DESIGN IN EVERY LAST DETAIL

Steering is light and smooth, so it can be manoeuvred and used in even the most congested areas and the narrowest passages with the minimum effort

SMALL AS A WALK BEHIND SCRUBBING MACHINE PRODUCTIVE AND COMFORTABLE AS AN ON BOARD MODEL

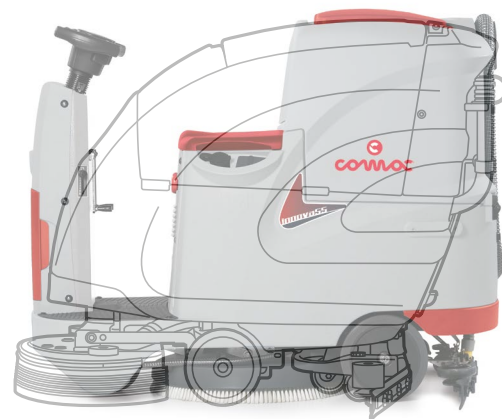
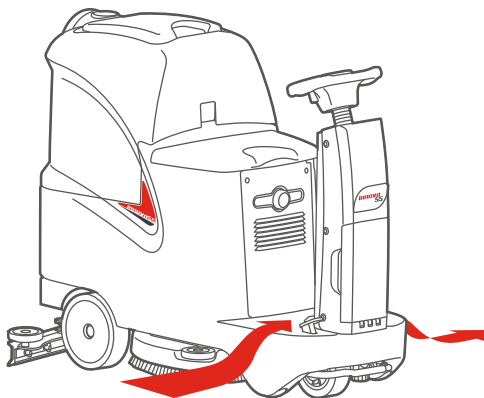

DESIGN

The lowered footboard and access from both sides make it safer and more practical.

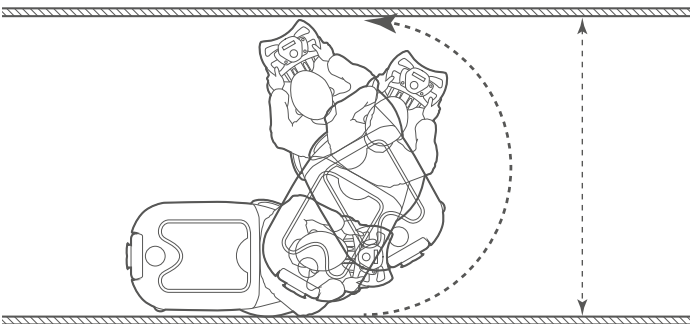

MINIMUM AISLE TURN 1540/60,8 mm/inch

Cleans perfectly along walls without any need for manual cleaning operations



Can be customised with accessories to increase productivity

INNOVA 55 TECHNOLOGIES



The tools that will save your time



Quick filling of the solution tank

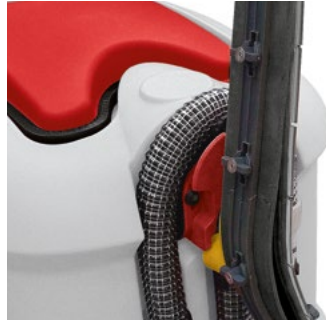

TOOL-HOLDER HOOK

It can hold the squeegee, the brush or the tank lid, useful for machine store or maintenance



On request Innova 55 B can be equipped with on board battery charger, making battery charging easy, safe and fast

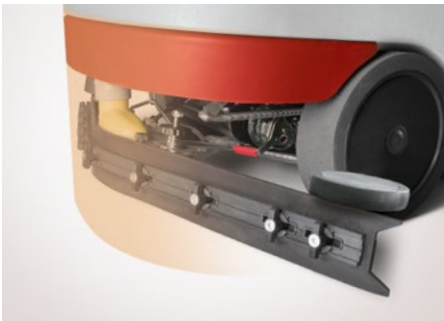

All the components are protected inside the machine unit. This means less risk of breaking in case of accidental impact, avoiding additional repair costs and ensuring a longer working life



Measuring cap, to add the proper detergent percentage

PROPER DAILY MAINTENANCE KEEPS CLEANING PERFORMANCES CONSTANT OVER TIME

Yellow color-code identifies the parts involved in daily maintenance. At the end of the shift the operator can easily and quickly find what parts have to be sanitized, without wasting time

DAILY MAINTENANCE



This increases machine efficiency and keeps its value high

CERTIFICATIONS



STANDARD EQUIPMENTS	Innova 55B
Comfort	
Hour meter	•
Eco Mode	•
Electronic control panel with diagnostics	•
Squeegee/brush base lift	Manual
Automatic brush uncoupling	•
Squeegee rubber blades usable on 4 sides	•
Color-coded parts for easy maintenance	•
Flexible filling hose with drop-stop	•
Water level indicator	•
Safety	
Emergency stop	•
Automatic parking brake	•
Antiskid wheels	•
Tool-holder hook	•
Dead man's switch	•
Reverse warning device	•
Horn	•

OPTIONAL	Innova 55B
CB (On-board Battery Charger)	•
CFC (Comac Fleet Care)	•
Kit for cleaning accessories	•
Blinking light	•

TECHNICAL DESCRIPTION		Innova 55B
Solution tank	l/gal	65/17,17
Recovery tank	l/gal	75/19,81
Voltage and nominal power	V/W	24/1220
Working width	mm/inch	560/22
Squeegee width	mm/inch	705-800/27,8-31,5
Working capacity up to	sq.m/h/sqft/h	3080/33152
Disc brush	(n.) mm/inch	(1) 560/22
Brush pressure	Kg/lbs	15/33
Brush motor	V/W	24/500
Brush revolution	rpm	160
Vacuum motor	V/W	24/420
Suction vacuum	mbar	125 (standard mode)/76 (Eco mode)
Acoustic level	db (A)	63
Traction	-	aut./rear
Traction motor	V/W	24/300
Forward speed	Km/h/mpg	0+5,5/3,4
Turning diameter	mm/inch	1980/77,95
Battery compartment dimensions (Lxhxw)	mm/inch	362x290x354/14x11x13
Max gradient at full load	%	8
Batteries (GEL) (q.tà) C5	V/Ah C5	12/112 (2)
Batteries (WET) (q.tà) C5	V/Ah C5	12/110 (2)
Batteries weight	Kg/lbs	76/167,5
Machine dimensions (Lxhxw)	mm/inch	1265x1030x600/50x40x24
Machine weight (without batteries)	Kg/lbs	110/242



COMAC S.p.A. Via Maestri del Lavoro, 13 - 37059 Santa Maria di Zevio - Verona - ITALY
Tel. 045 8774222 - Fax 045 8750303 - www.comac.it - com@comac.it

Organisation certified by Q.C.B. Italia ISO 9001:2015, ISO 14001:2015, OHSAS 18001:2007

